

Fisher-Price®

Musical Activity Walker™



Product Number B0322

Please keep this instruction sheet for future reference,
as it contains important information.

Requires three "AA" (LR6) **alkaline** batteries (not included).

Adult assembly is required for battery installation.

Tool required for battery installation: Phillips screwdriver (not included)

IMPORTANT! An adult should convert this toy from:
activity center to walker or walker to activity center.

**Brilliant
BASICS™**

Discover what's possible™...www.fisher-price.com

Battery Installation

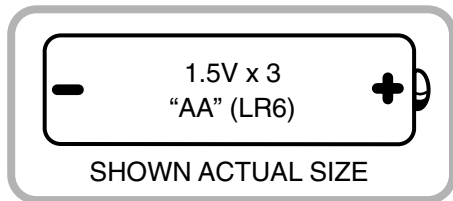
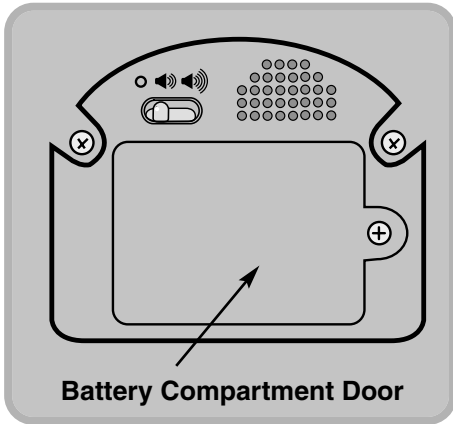

- Locate the battery compartment door on the bottom of the toy.
- Loosen the screw in the battery compartment door with a Phillips screwdriver. Remove the battery compartment door.
- Insert three "AA" (LR6) **alkaline** batteries, as indicated inside the battery compartment.

Hint: We recommend using **alkaline** batteries for longer life.

- Replace the battery compartment door and tighten the screw with a Phillips screwdriver. Do not over-tighten.
- When sounds from this toy become faint or stop, it's time for an adult to change the batteries!

Battery Safety Information

Batteries may leak fluids that can cause a chemical burn injury or ruin your toy (product). To avoid battery leakage:

- Do not mix old and new batteries or batteries of different types: alkaline, standard (carbon-zinc) or rechargeable (nickel-cadmium).
- Insert batteries as indicated inside the battery compartment.
- Remove batteries during long periods of non-use. Always remove exhausted batteries from the toy. Dispose of batteries safely. Do not dispose of batteries in a fire. The batteries may explode or leak.
- Never short-circuit the battery terminals.
- Use only batteries of the same or equivalent type as recommended.
- Do not charge non-rechargeable batteries.
- Remove rechargeable batteries from the toy (product) before charging.
- If removeable, rechargeable batteries are used, they are only to be charged under adult supervision.

Label Application

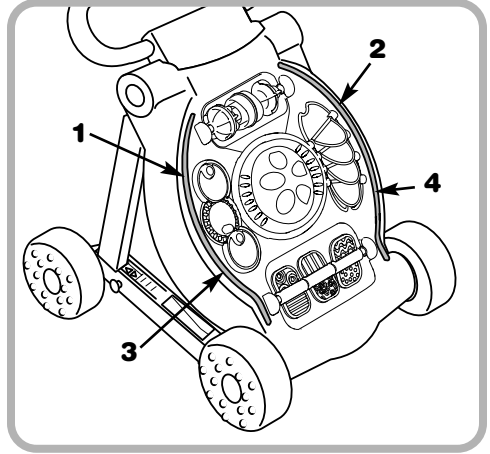

Proper label application will help to keep the labels looking their best.

- Wash your hands before applying the labels.
- Make sure the areas where the labels will be applied are clean and dry. Wipe this product with a clean, soft, dry cloth to remove any dust or oils.
- For best results, do not attempt to apply a label more than once.
- Apply the labels as shown in the illustration.

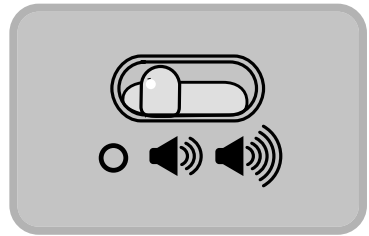

Sounds and Music in Walker - Upright Position



- Locate the power/volume switch on back of the toy.
- Slide the switch to the desired position: Off  ; or with low volume  ; or on with high volume .

When baby pushes the walker or spins the center ball (in upright position only), lively music plays!

Walker - Upright Position



WARNING

To prevent pinching or crushing, always lock the product in its upright position or in its folded position.

Hint: The Musical Activity Walker is ready to use as an activity center in the folded position. Follow the instructions below to convert the Musical Activity Walker from an activity center - folded position to the walker - upright position.

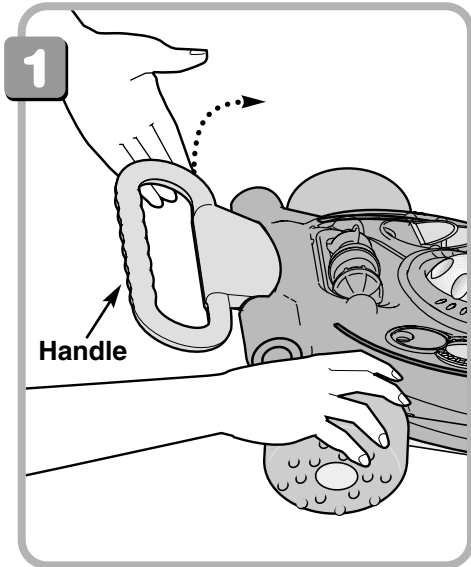

- While holding one of the rear wheels, lift the handle.

Hint: This may require some force.

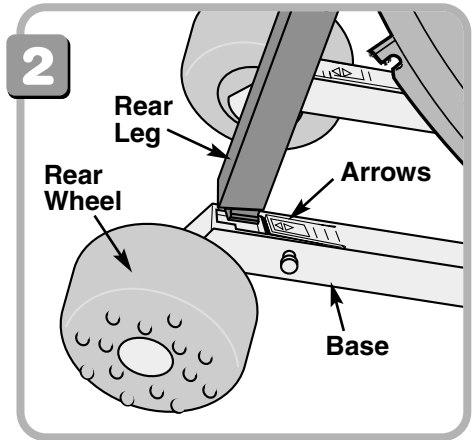

To lock in the upright position:

- Position a rear leg over the arrow on the base, near the rear wheel.
- Push the rear leg down and slide it toward the rear wheel until you hear a “click”.
- Pull up on the rear leg to be sure it is secure.
- Repeat this procedure to attach the other rear leg to the base.

IMPORTANT! To avoid pinching, be sure your fingers are not near the arrows on the base when locking the rear legs into position.

Activity Center - Folded Position

Hint: Follow the instructions below to convert the Musical Activity Walker from a walker to an activity center - folded position.

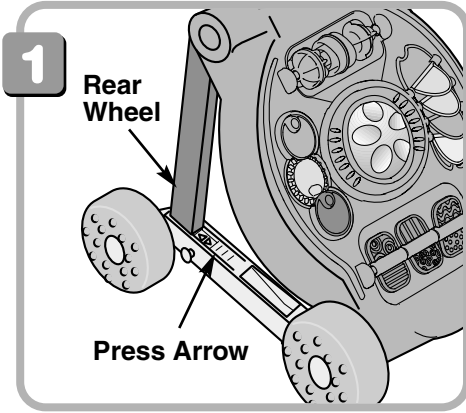

- Position the Activity Walker so that the side is facing you.
- To unlock the rear leg, press the arrow near the rear wheel, as shown.

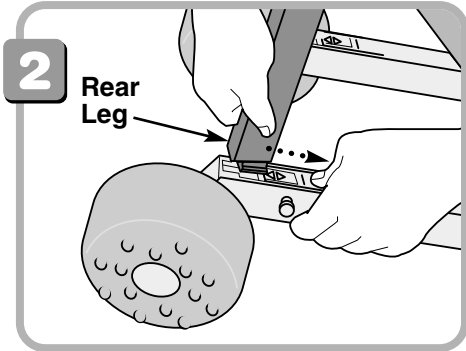

- While pressing the arrow, carefully slide the rear leg slightly toward the front wheel.

IMPORTANT! Be careful to move your fingers from the arrow after you have unlocked the leg to avoid pinching.

- Repeat this procedure to unlock the rear leg on the other side of the toy.

To lock in the folded position:

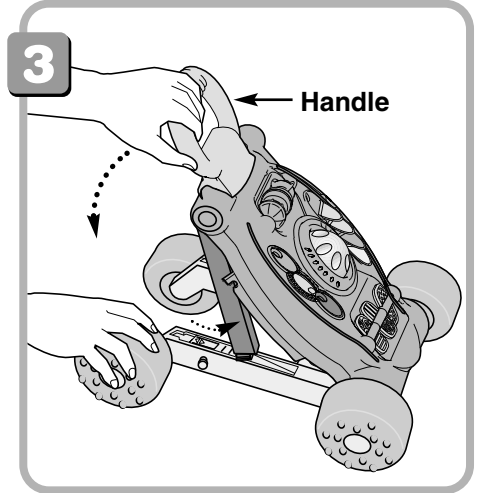

- While holding one of the rear wheels, push the handle down toward the rear wheels until it “snaps” into place.

IMPORTANT! Make sure this product is locked into position by securely “snapping” into place.

Care

Wipe this toy with a clean cloth dampened with a mild soap and water solution.

FCC Statement (United States Only)

Note: This equipment has been tested and found to comply with the limits for a Class B digital device, pursuant to Part 15 of the FCC Rules. These limits are designed to provide reasonable protection against harmful interference in a residential installation. This equipment generates, uses and can radiate radio frequency energy and, if not installed and used in accordance with the instructions, may cause harmful interference to radio communications. However, there is no guarantee that interference will not occur in a particular installation. If this equipment does cause harmful interference to radio or television reception, which can be determined by turning the equipment off and on, the user is encouraged to try to correct the interference by one or more of the following measures:

- Reorient or relocate the receiving antenna.
- Increase the separation between the equipment and receiver.
- Consult the dealer or an experienced radio/TV technician for help.

Note: Changes or modifications not expressly approved by the manufacturer responsible for compliance could void the user's authority to operate the equipment.

Consumer Information

Questions? We'd like to hear from you!

Call Fisher-Price® Consumer Relations, toll-free at
1-800-432-5437, 8 AM - 6 PM EST Monday through Friday.
Hearing-impaired consumers using TTY/TDD equipment, please call
1-800-382-7470. Or, write to: Fisher-Price® Consumer Relations,
636 Girard Avenue, East Aurora, New York 14052.

For countries outside the United States:

CANADA: Questions? 1-800-567-7724, Mattel Canada Inc., 6155 Freemont Blvd.,
Mississauga, Ontario L5R 3W2.

GREAT BRITAIN: Mattel UK Ltd, Vanwall Business Park, Maidenhead SL6 4UB. Helpline: 01628 500302.

AUSTRALIA: Australia: Mattel Australia Pty. Ltd., 658 Church Street, Locked Bag #870, Richmond,
Victoria 3121 Australia. Consumer Advisory Service 1300 135 312.

NEW ZEALAND: 16-18 William Pickering Drive, Albany 1331, Auckland.

ASIA: Mattel East Asia Ltd, Room 1106, South Tower, World Finance Centre, Harbour City, Tsimshatsui, HK, China.



Fisher-Price, Inc., a subsidiary of Mattel, Inc., East Aurora, NY 14052 U.S.A.
©2003 Mattel, Inc. All Rights Reserved. ® and ™ designate U.S. trademarks of Mattel, Inc.